

SEWING MACHINE TABLE
COMFORT JUNIOR 1
СТОЛ ДЛЯ ШВЕЙНОЙ МАШИНЫ

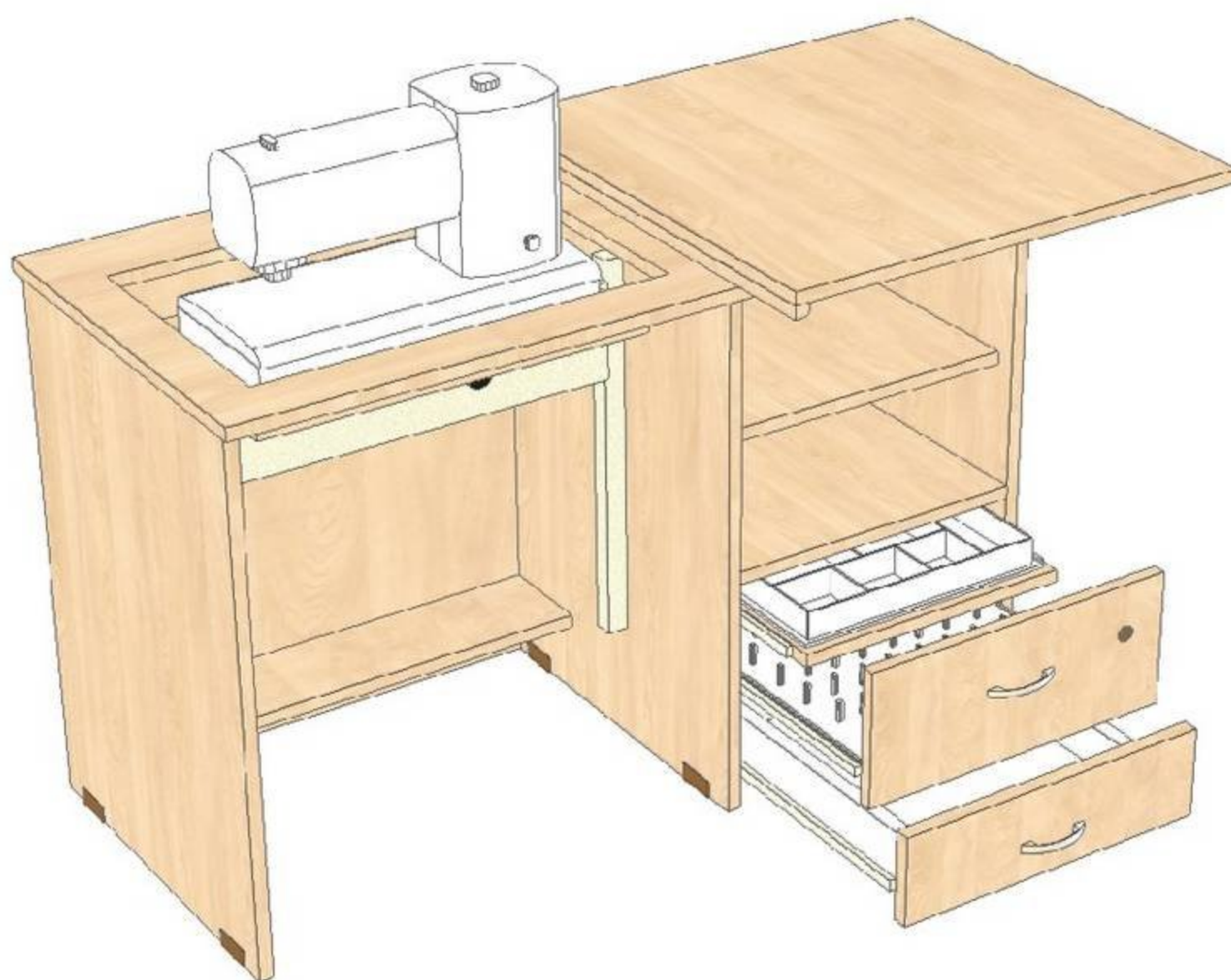

SYMBOLS



ATTENTION

ВНИМАНИЕ



ASSEMBLY & ADJUSTMENT

СБОРКА РЕГУЛИРОВКА

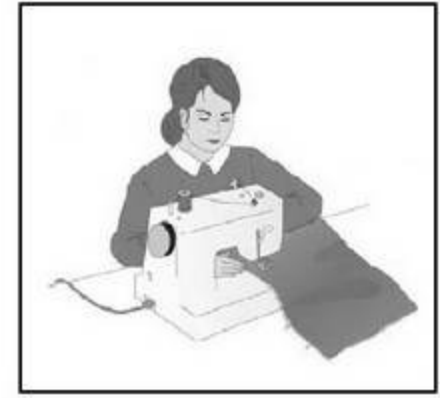

OPERATION

ЭКСПЛУАТАЦИЯ



STORAGE

ХРАНЕНИЕ

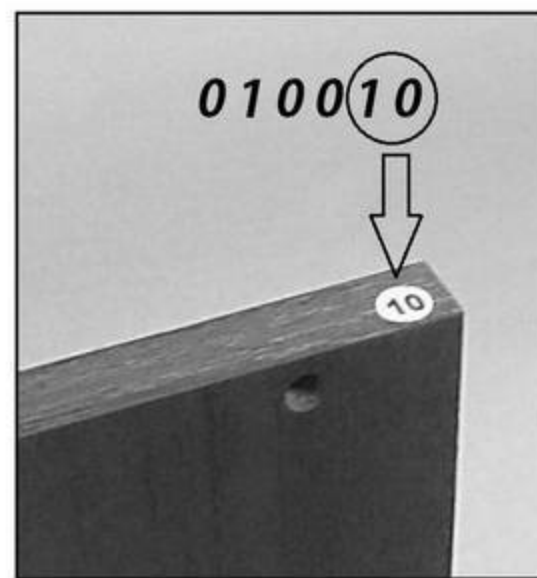

INDICATING MARK

ОБОЗНАЧЕНИЕ



SPECIAL OPERATION

СПЕЦИАЛЬНЫЕ ОПЕРАЦИИ

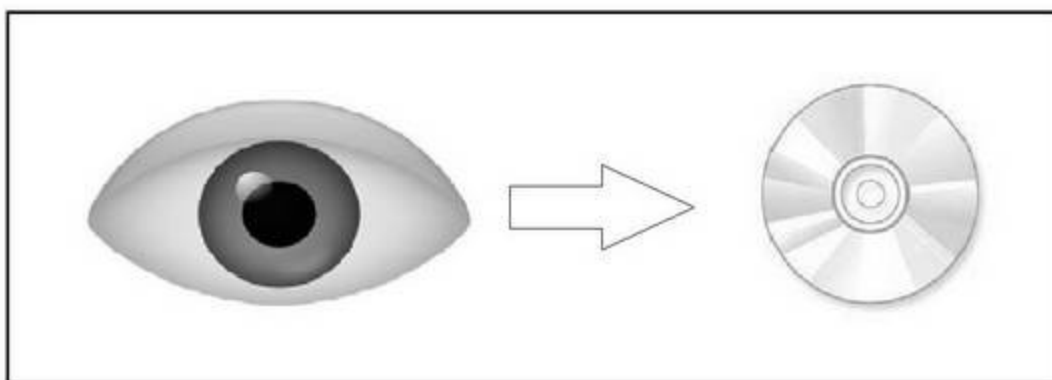

WATCH DVD

СМОТРЕТЬ DVD

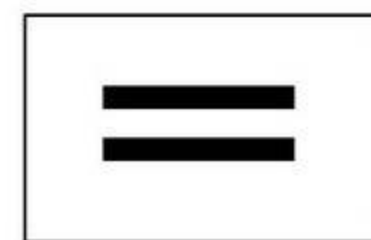

EQUALITY

РАВЕНСТВО

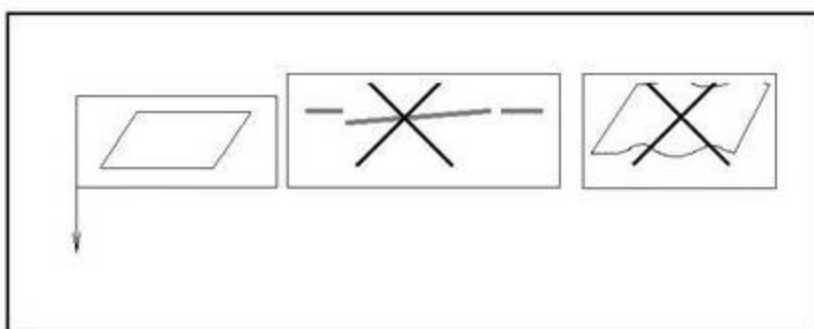

















EVEN SURFACE

РОВНАЯ ПОВЕРХНОСТЬ

010001 1x	010003 1x	010004 1x	010006 1x	010008 1x	010009 1x
010011 1x	010012 1x	010013 1x	010014 1x	010016 1x	010028 2x
010033	010034	010041 1x			

 020006 2x	 020011 1x	 020012 1x	 020020 4x	 020024 6x
 3x 020015 DR		 3x 020015 DL		
 3x 020013 CR		 3x 020013 CL		

030001  3 * 16 12x	030002  3,5 * 16 36x	030003  6,2 * 50 20x		030005  4,2 * 16 10x	030006  2,9 * 13 2x
030007  φ 6 2x	030008  φ 4 4x	030009  M4 * 20 4x	030010  φ 6 4x	030011  φ 15 18x	030012  φ 18 9x
030013  L = 35 9x	030014  φ 15 h12 9x	030015  φ 8 * 30 10x	030016  φ 8 * 30 2x	030017  φ 15 h12 2x	030027  M4 * 35 2x

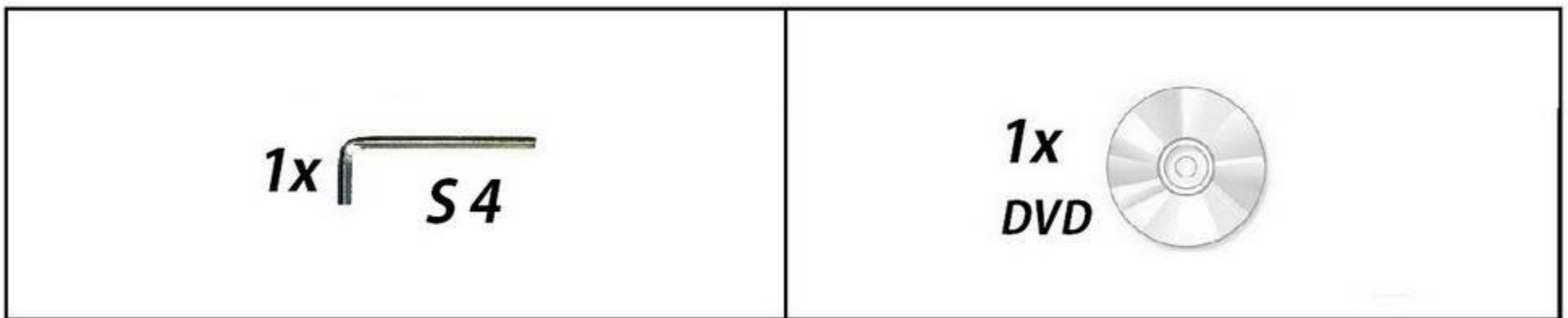
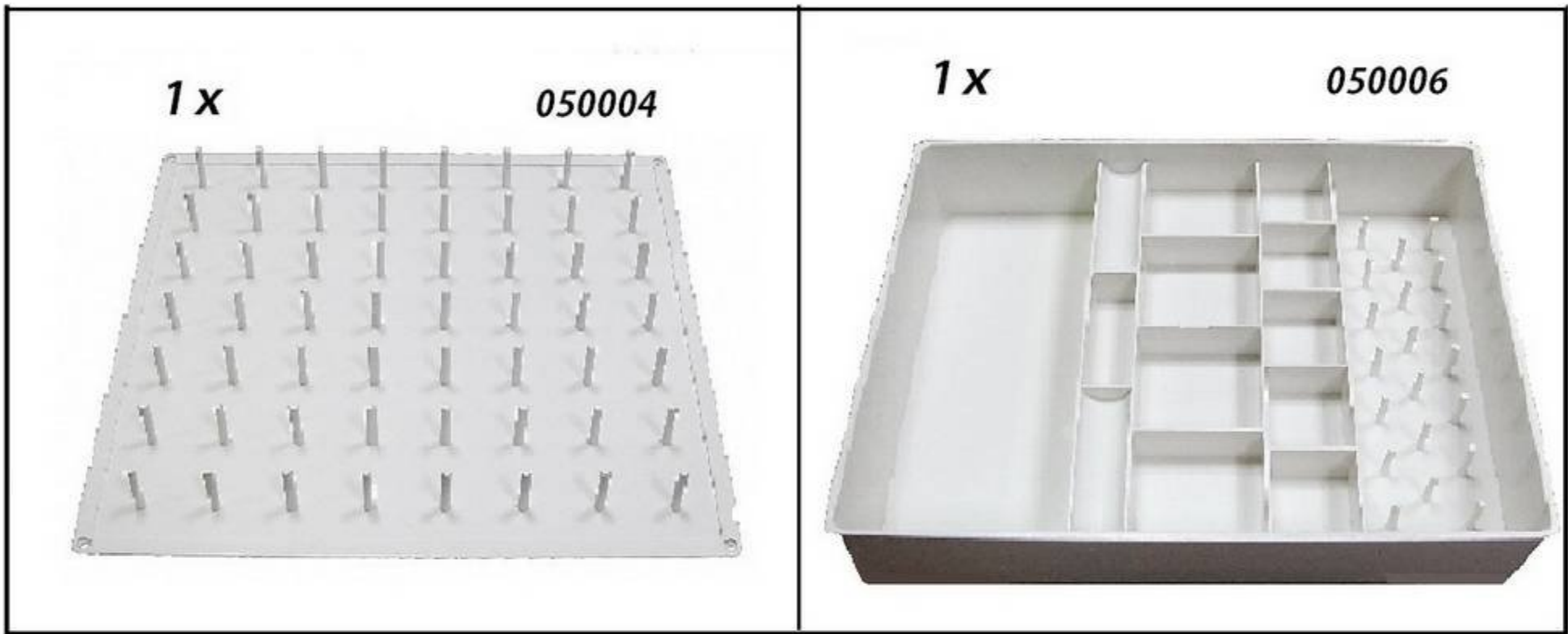
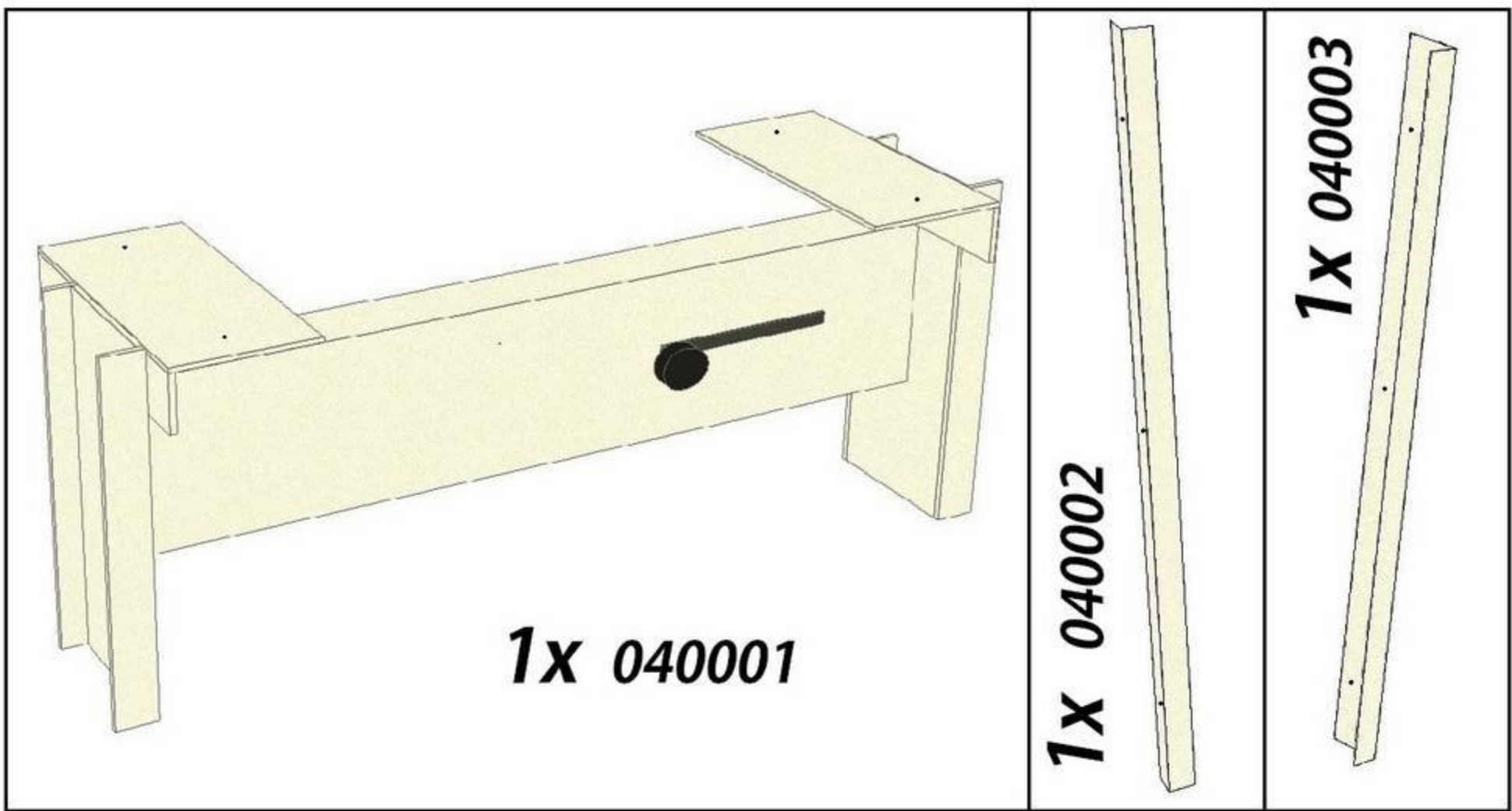

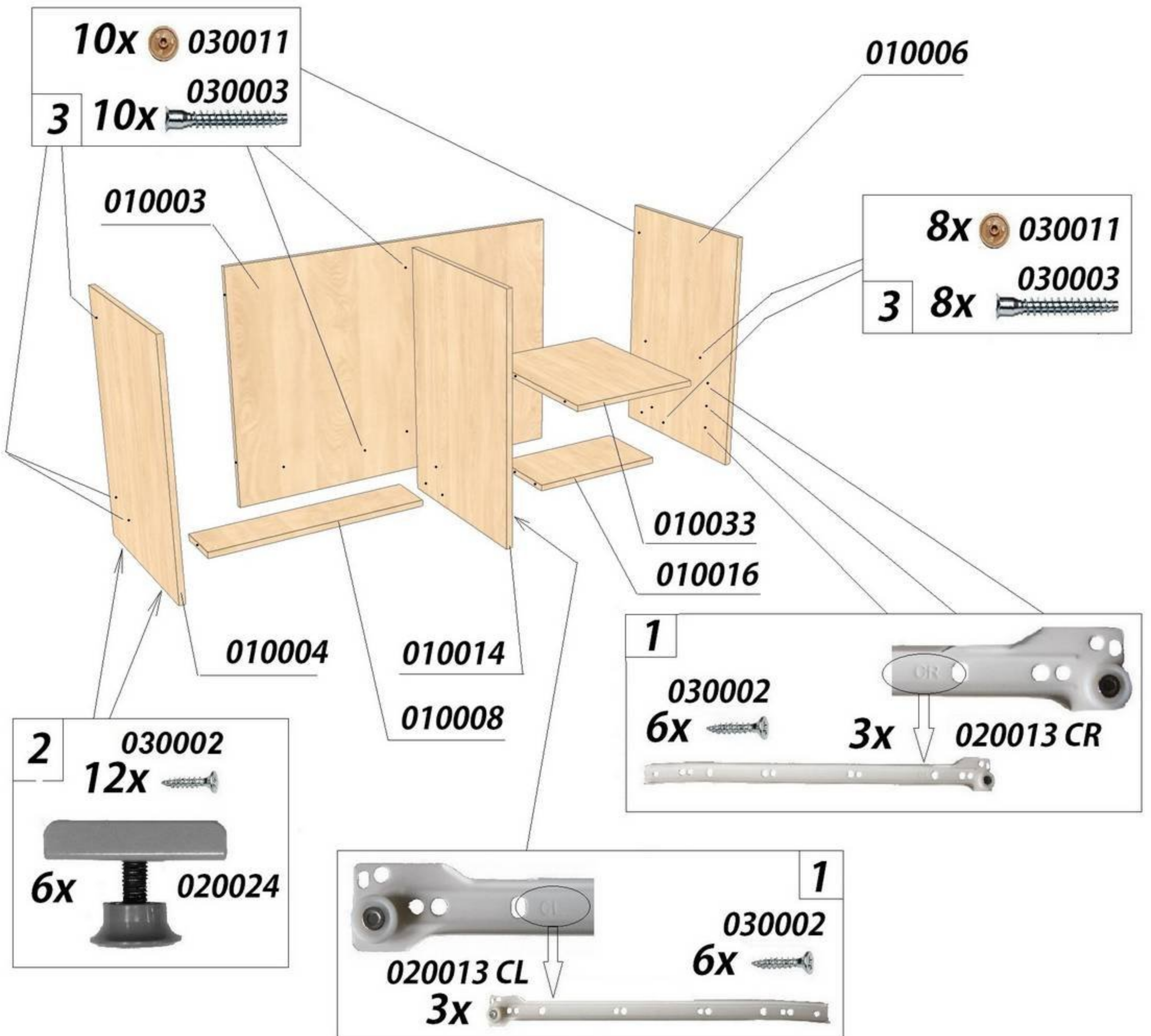

010001

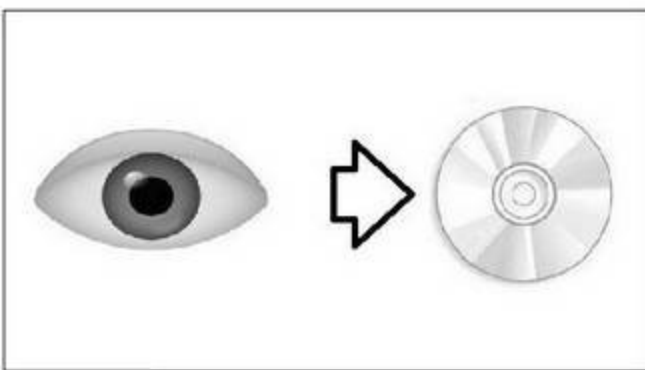
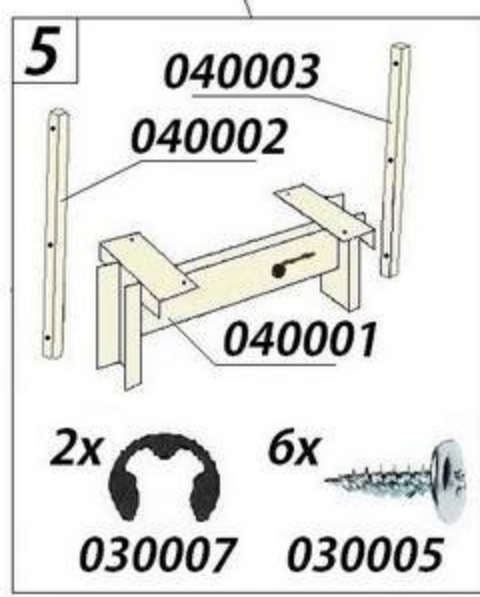
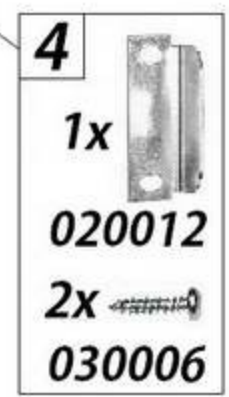
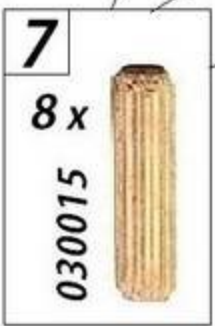
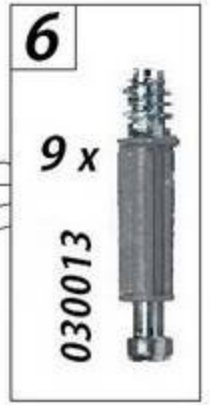

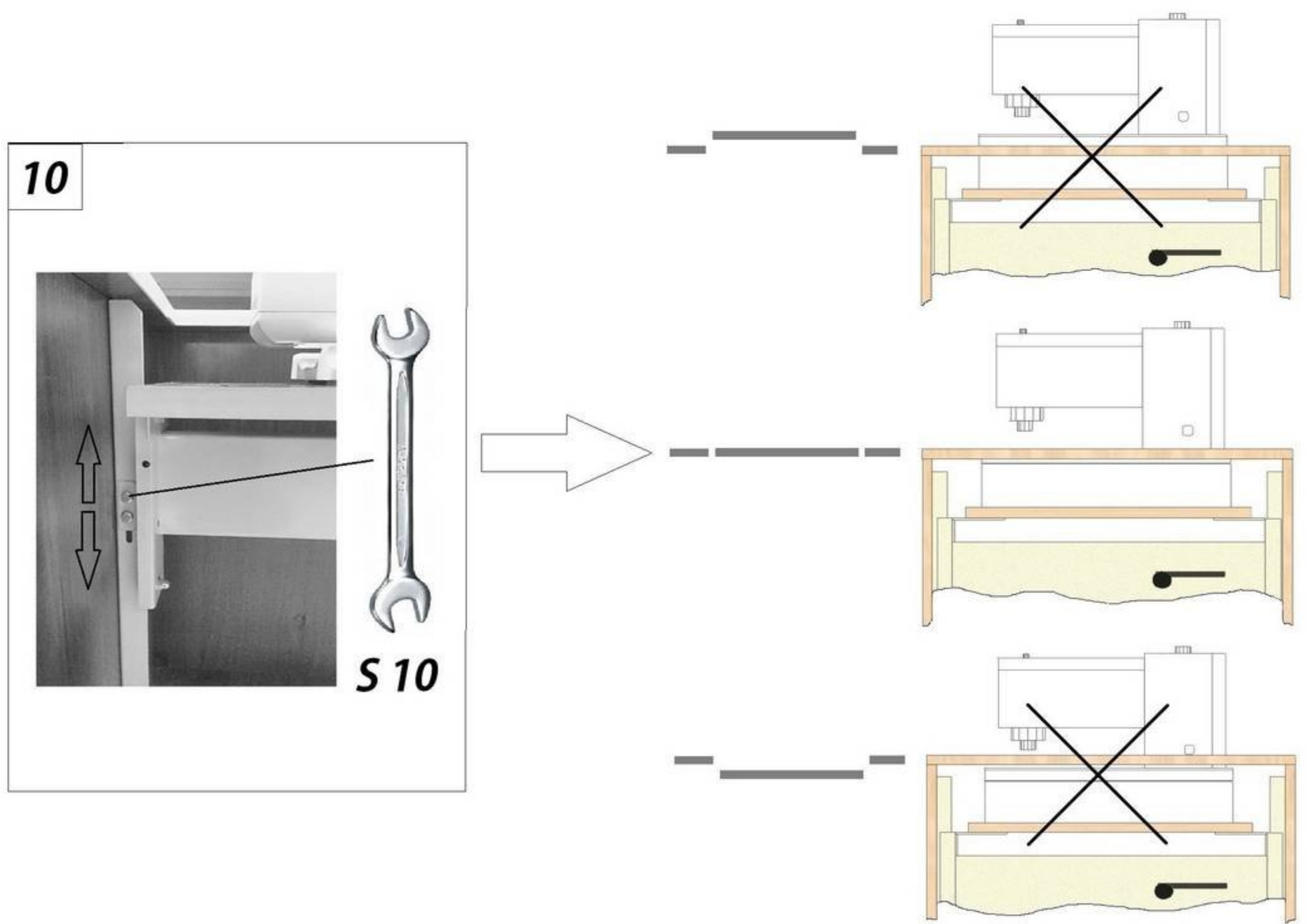
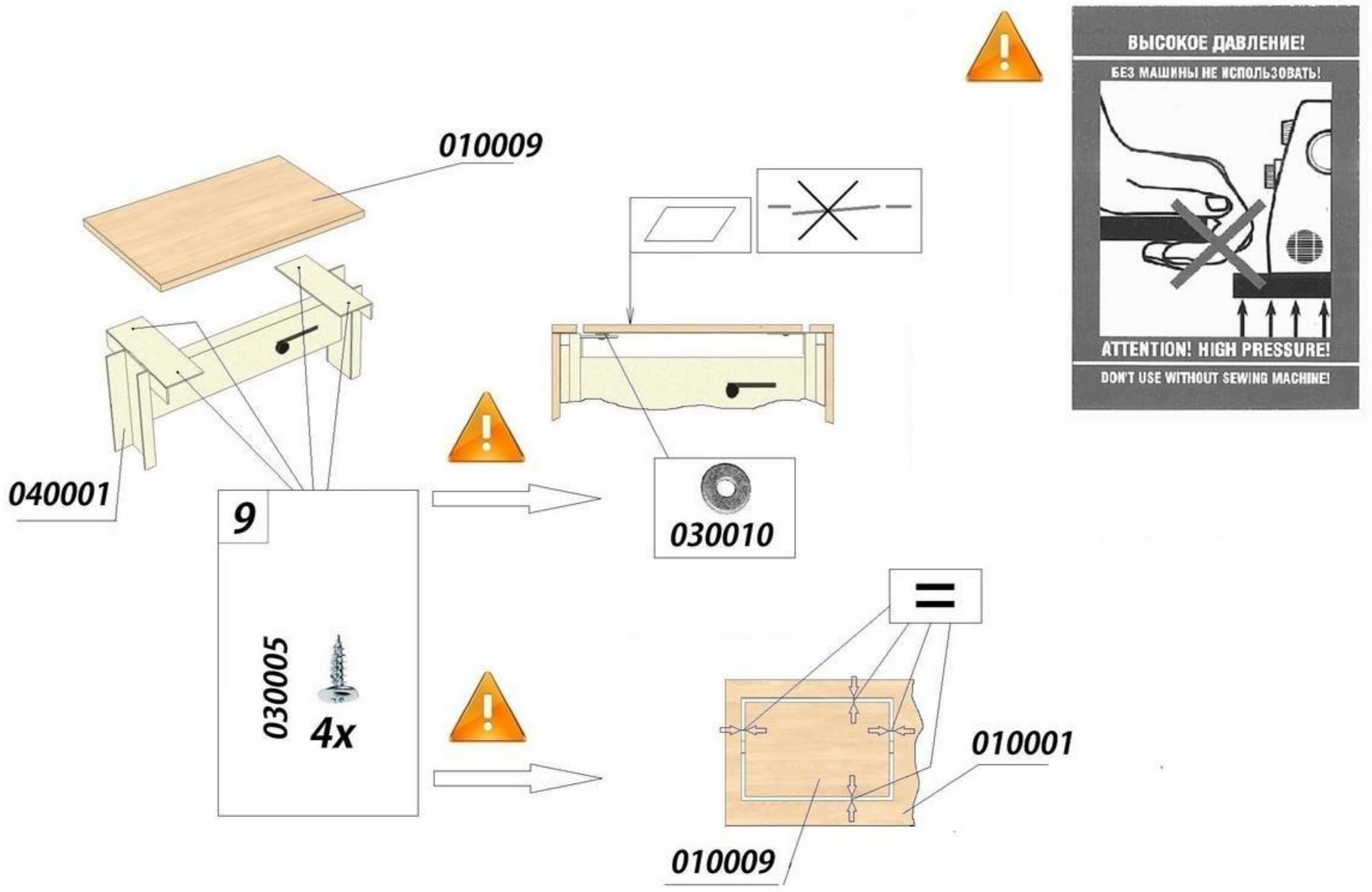



15

2x 030001

1x 020015 DR

030016 **12**

2x

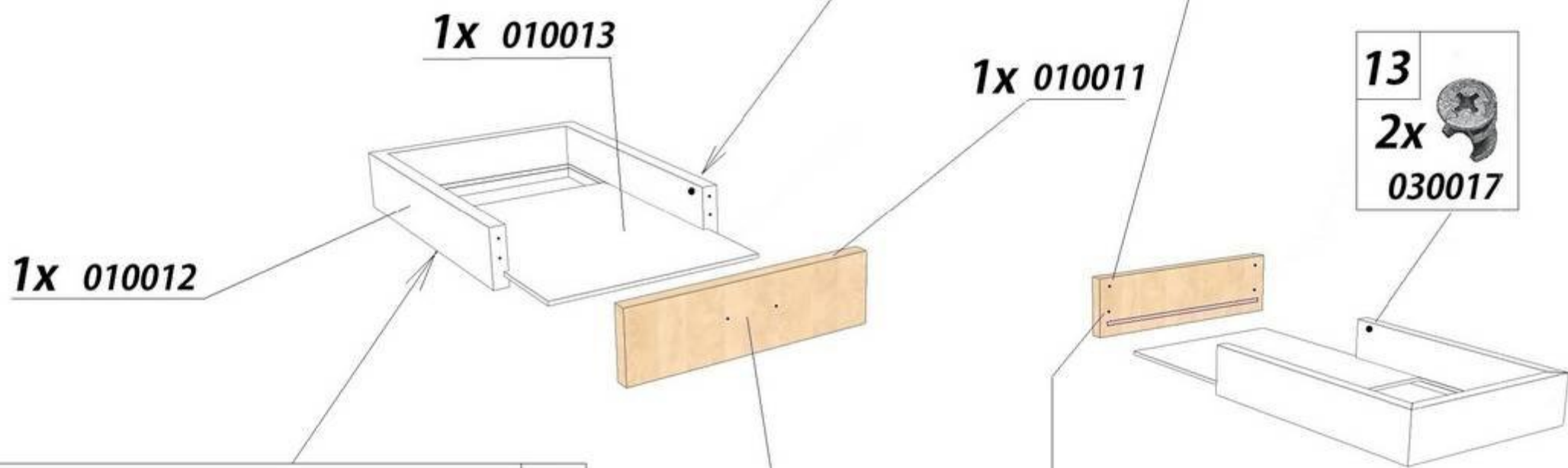

15

1x 020015 DL

2x 030001

14 030009 030008

2x 2x

1x 020006

11

030015

2x

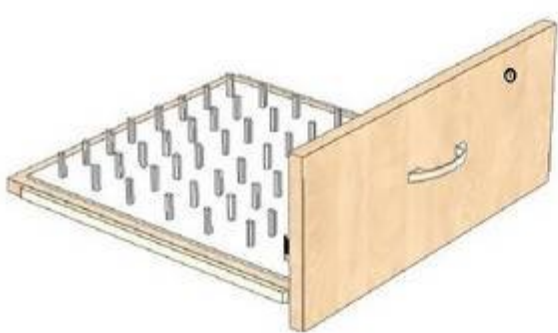

16

030002

4x

1x 050004

20

030001

2x

1x 020015 DR

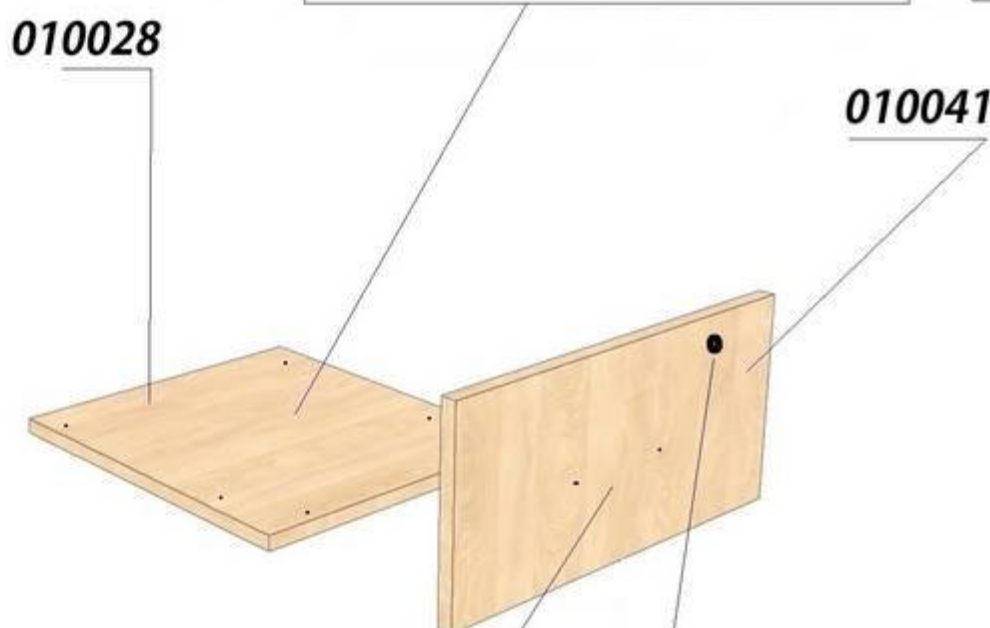

17

030003

2x

18 030027 030008

2x 2x

1x 020006

19 020011

1x

4x 030002

20

030001

2x

1x 020015 DL

