

***KNITTING MACHINE TABLE***

***COMFORT***

***СТОЛ ДЛЯ ВЯЗАЛЬНОЙ МАШИНЫ***

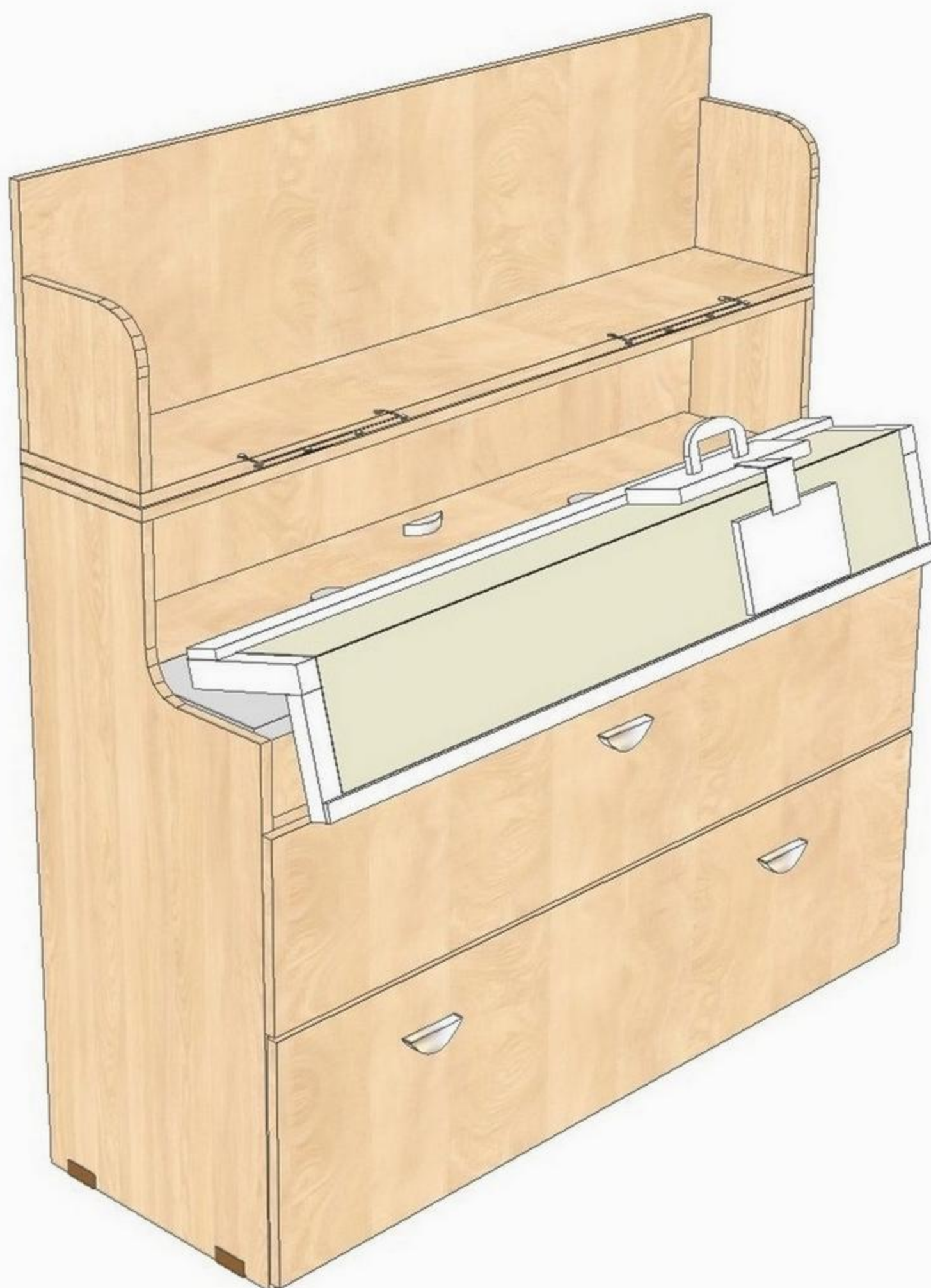

# ***SYMBOLS***



***ATTENTION***

***ВНИМАНИЕ***



***ASSEMBLY & ADJUSTMENT***

***СБОРКА РЕГУЛИРОВКА***

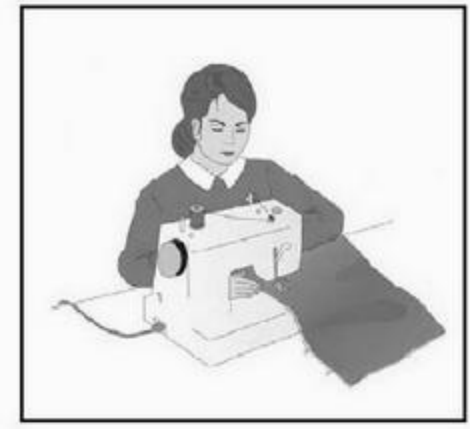

***OPERATION***

***ЭКСПЛУАТАЦИЯ***



***STORAGE***

***ХРАНЕНИЕ***

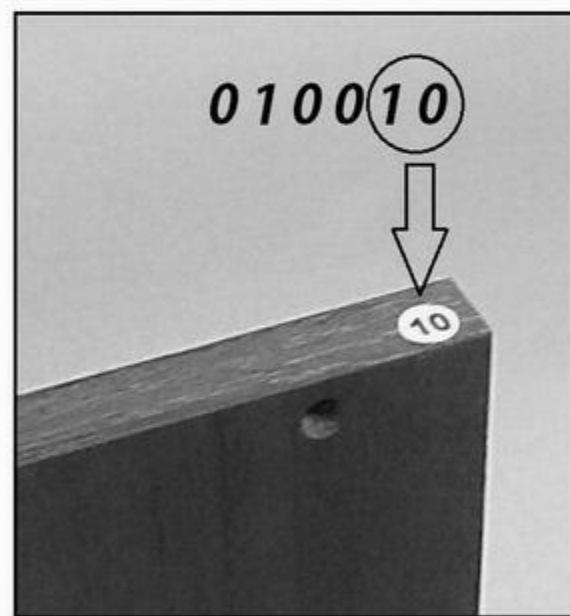

***INDICATING MARK***

***ОБОЗНАЧЕНИЕ***

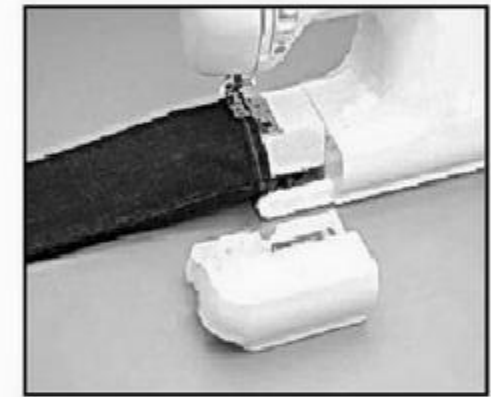

***SPECIAL OPERATION***

***СПЕЦИАЛЬНЫЕ ОПЕРАЦИИ***

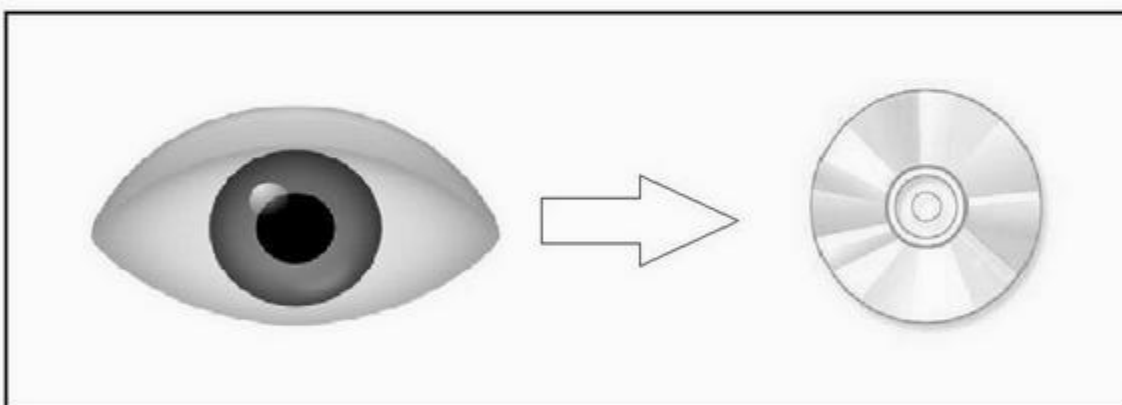

***WATCH DVD***

***СМОТРЕТЬ DVD***

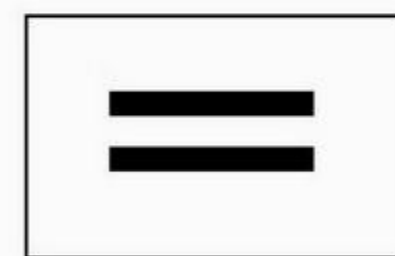

***EQUALITY***



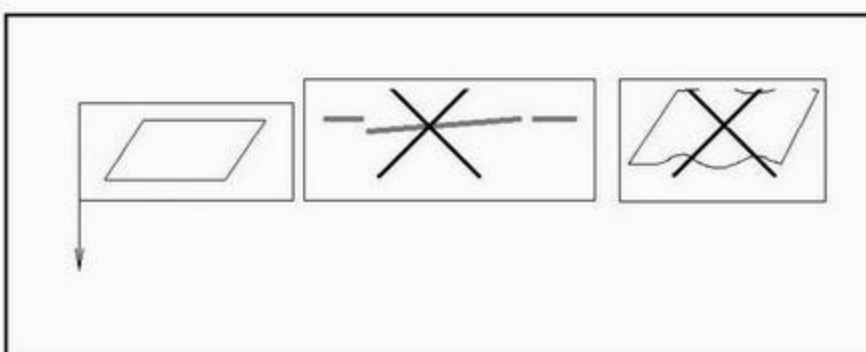







***РАВЕНСТВО***

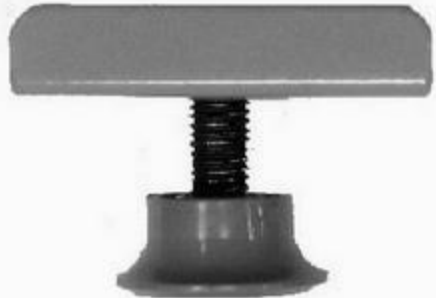





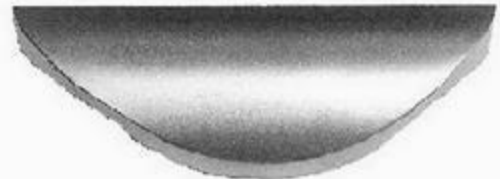
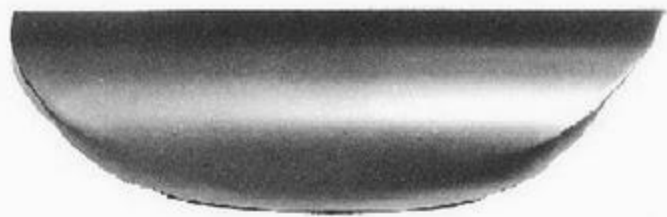







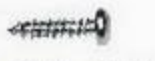

***EVEN SURFACE***

***РОВНАЯ ПОВЕРХНОСТЬ***

010001 1x	010002 1x	010003 1x	010004 1x
010005 1x	010006 1x	010007 1x	010008 1x
010010 1x	010011 1x	010017 1x	010018 1x
010024 1x	010025 1x	010026 1x	010027 1x
010029 1x	010033 1x	010035 1x	010036 1x

<b>2x 020007</b> 	<b>6x 020023</b> 	<b>4x 020024</b> 
<b>2x 020025</b> 	<b>2x 020026</b> 	<b>2x 020027</b> 
<b>020028</b>  <b>2x</b>	<b>2x 020029</b> 	<b>1x 020030</b> 
<b>5x 020031</b> 	<b>2x 020032</b> 	

<b>030001</b>  <b>3 * 16</b> <b>4x</b>	<b>030002</b>  <b>3,5 * 16</b> <b>22x</b>	<b>030003</b>  <b>6,2 * 50</b> <b>32x</b>	<b>030005</b>  <b>4,2 * 16</b> <b>20x</b>	<b>030006</b>  <b>2,9 * 13</b> <b>4x</b>	<b>030008</b>  <b>φ4</b> <b>12x</b>	<b>030009</b>  <b>M4 * 20</b> <b>12x</b>
<b>030011</b>  <b>φ15</b> <b>32x</b>	<b>030012</b>  <b>φ18</b> <b>21x</b>	<b>030013</b>  <b>L = 35</b> <b>21x</b>	<b>030014</b>  <b>φ15 h12</b> <b>21x</b>	<b>030015</b>  <b>φ8 * 30</b> <b>12x</b>	<b>030025</b>  <b>M5 * 30</b> <b>8x</b>	<b>030026</b>  <b>8x</b>

<b>2x 040004</b> 
---

<b>2x 050001</b> 
--

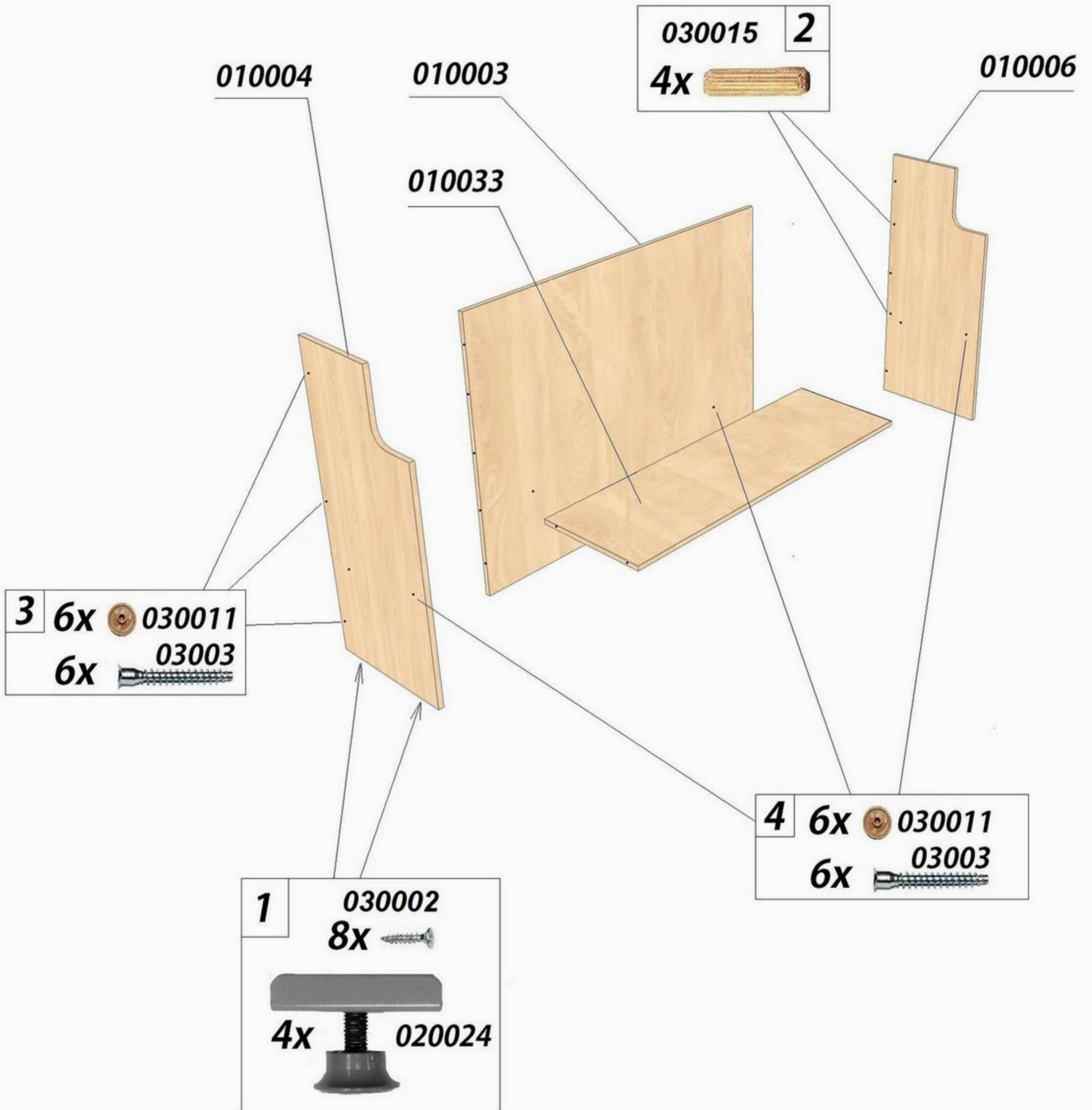

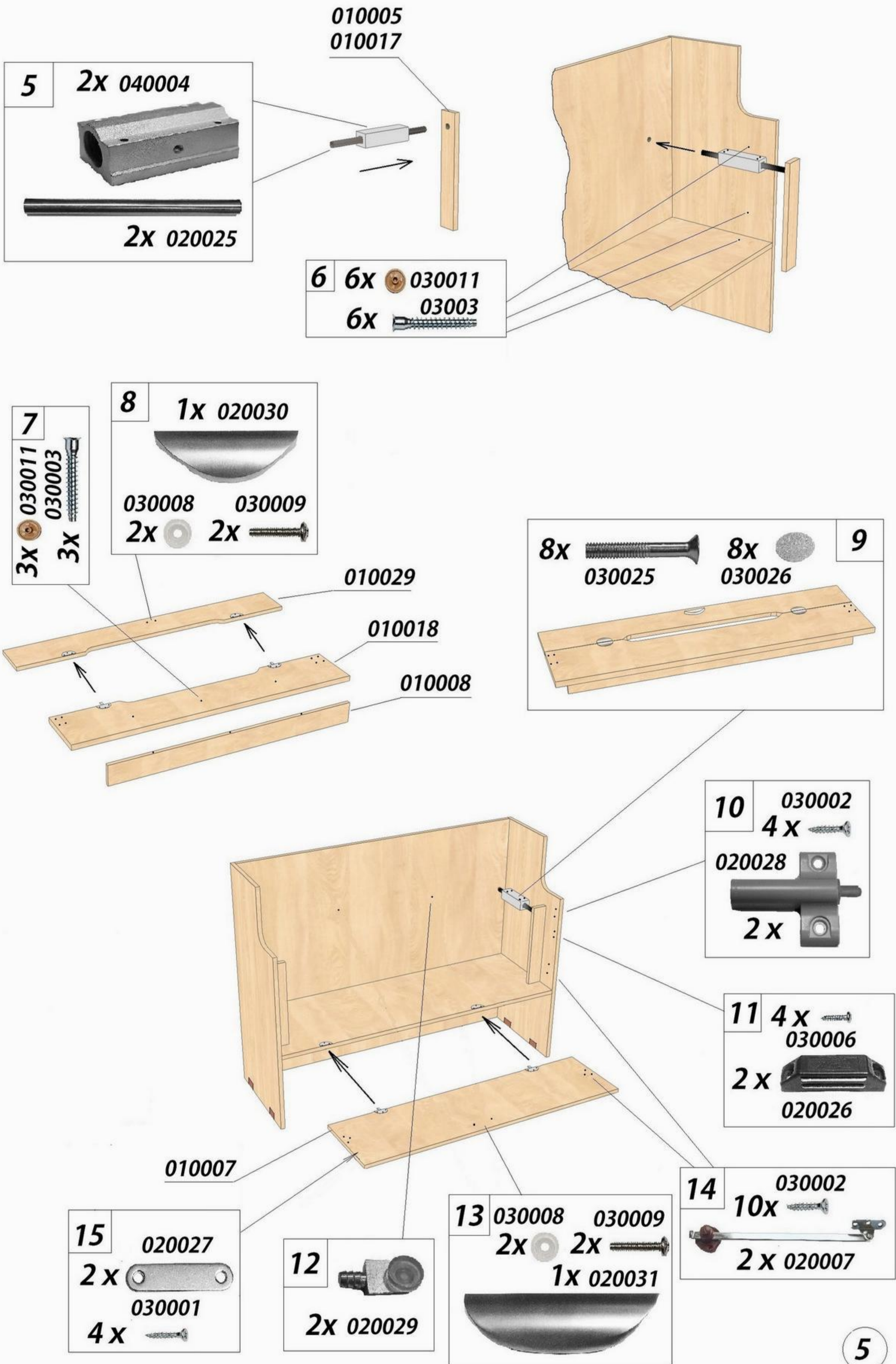



16

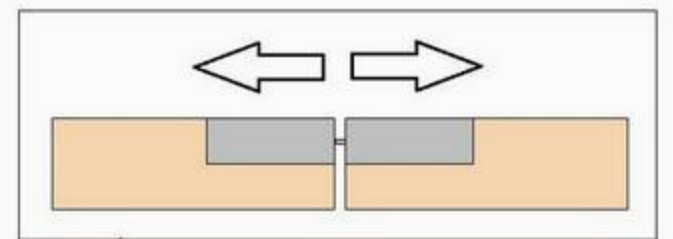
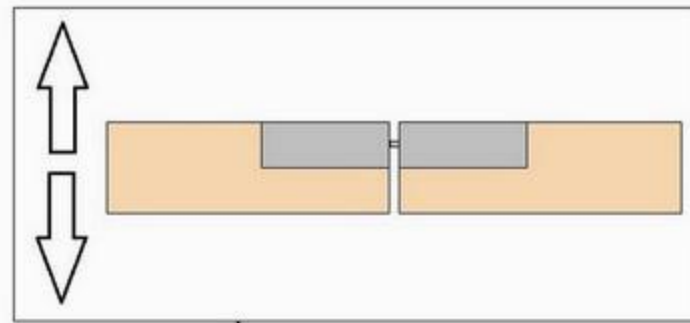
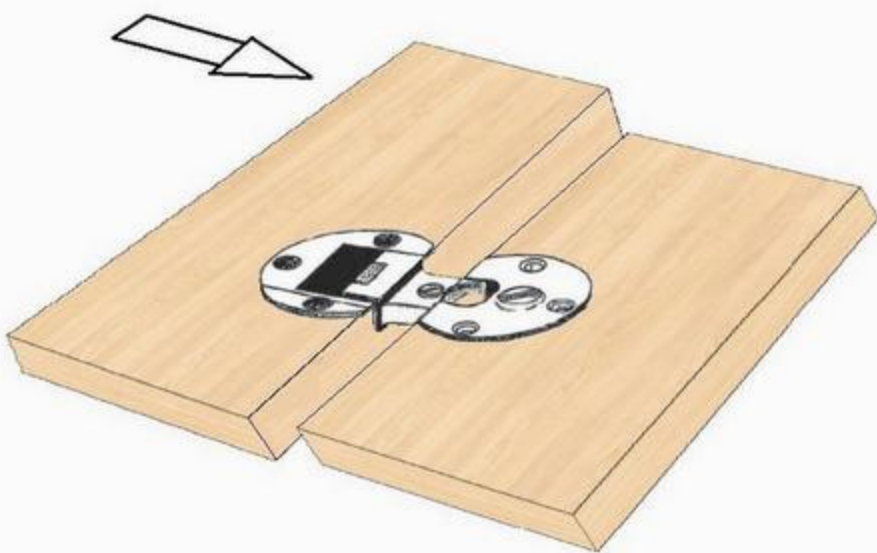
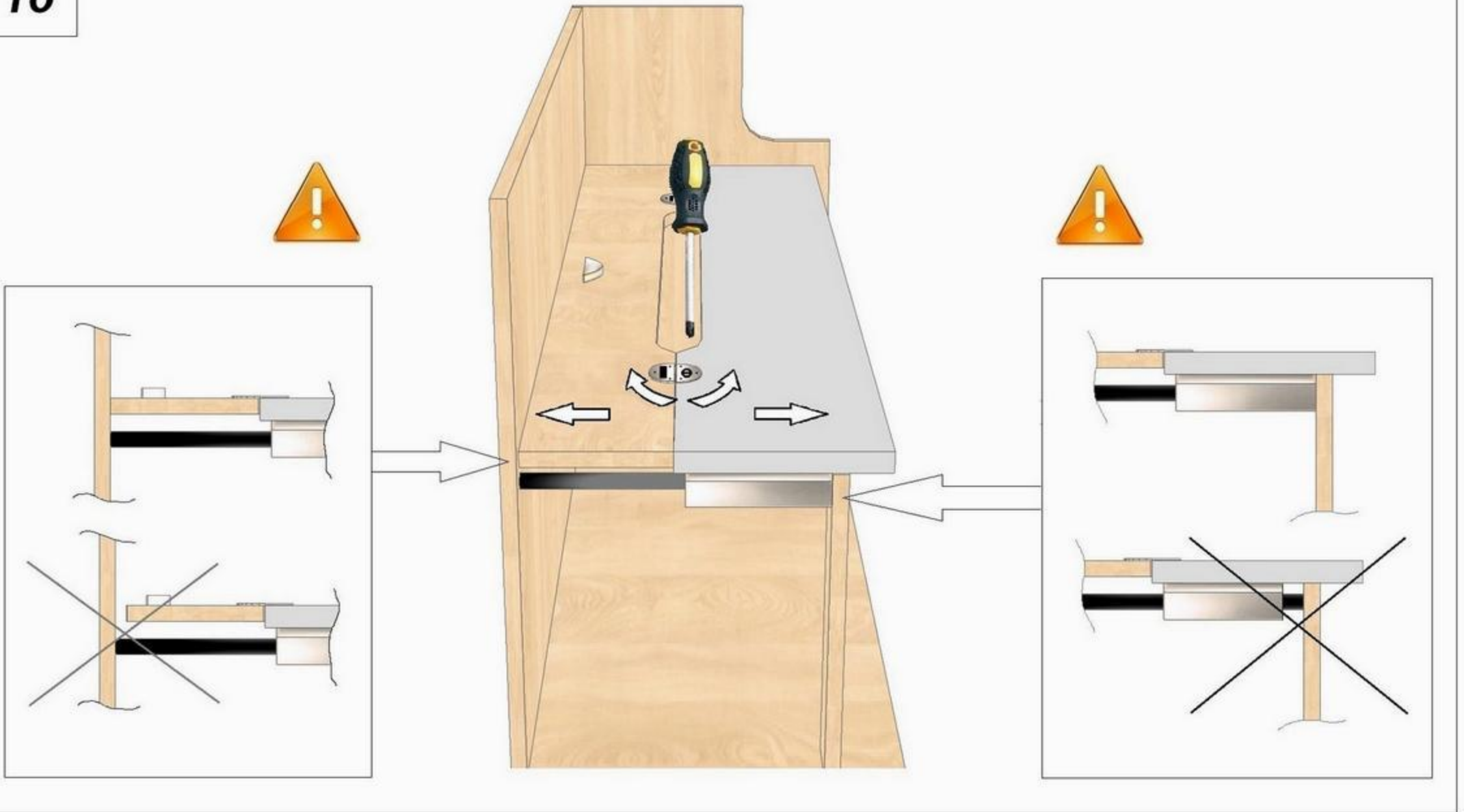

6

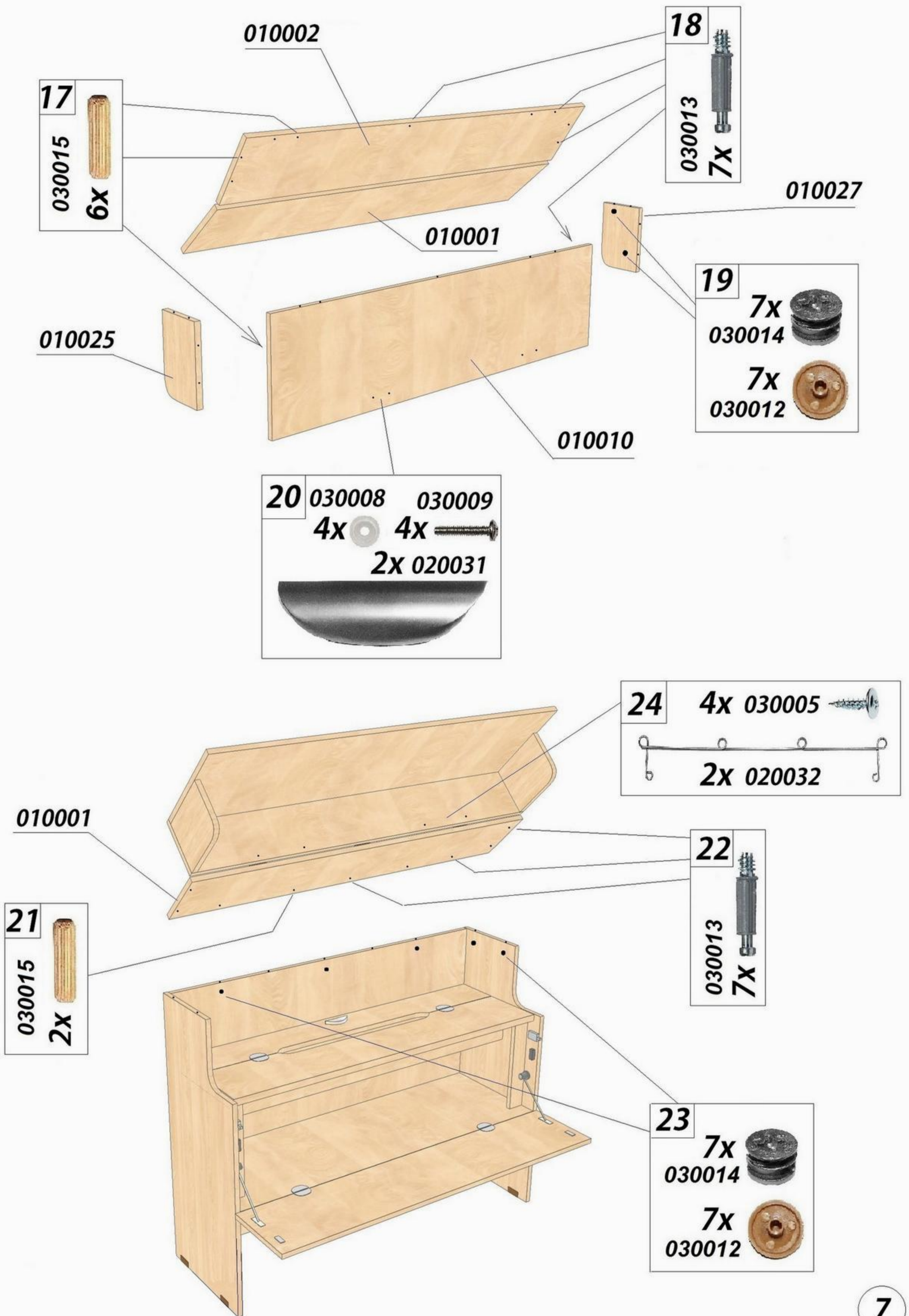

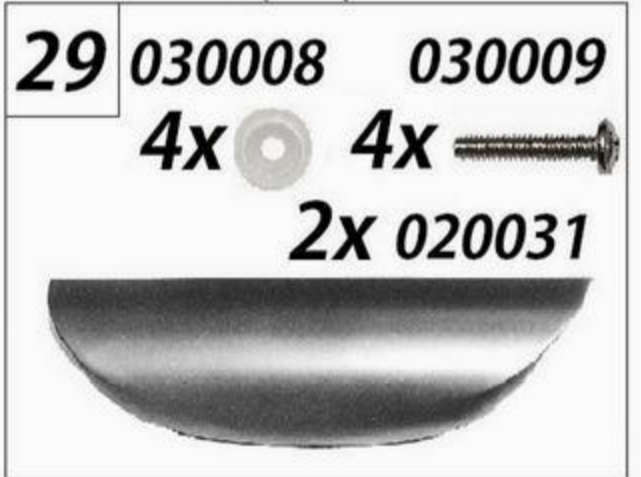
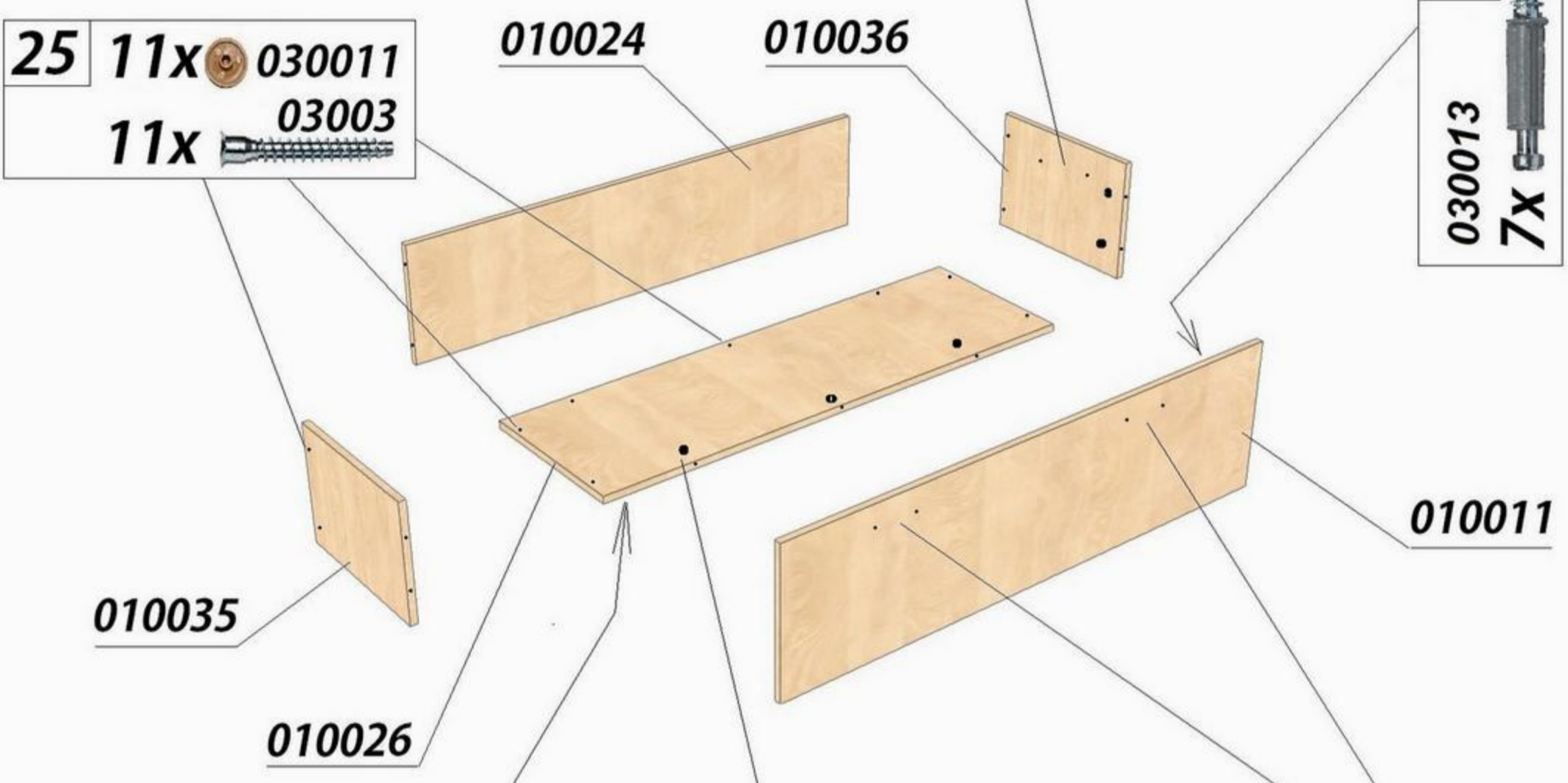
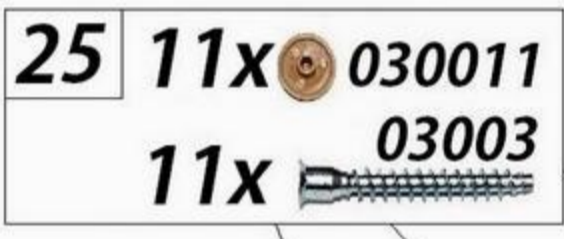



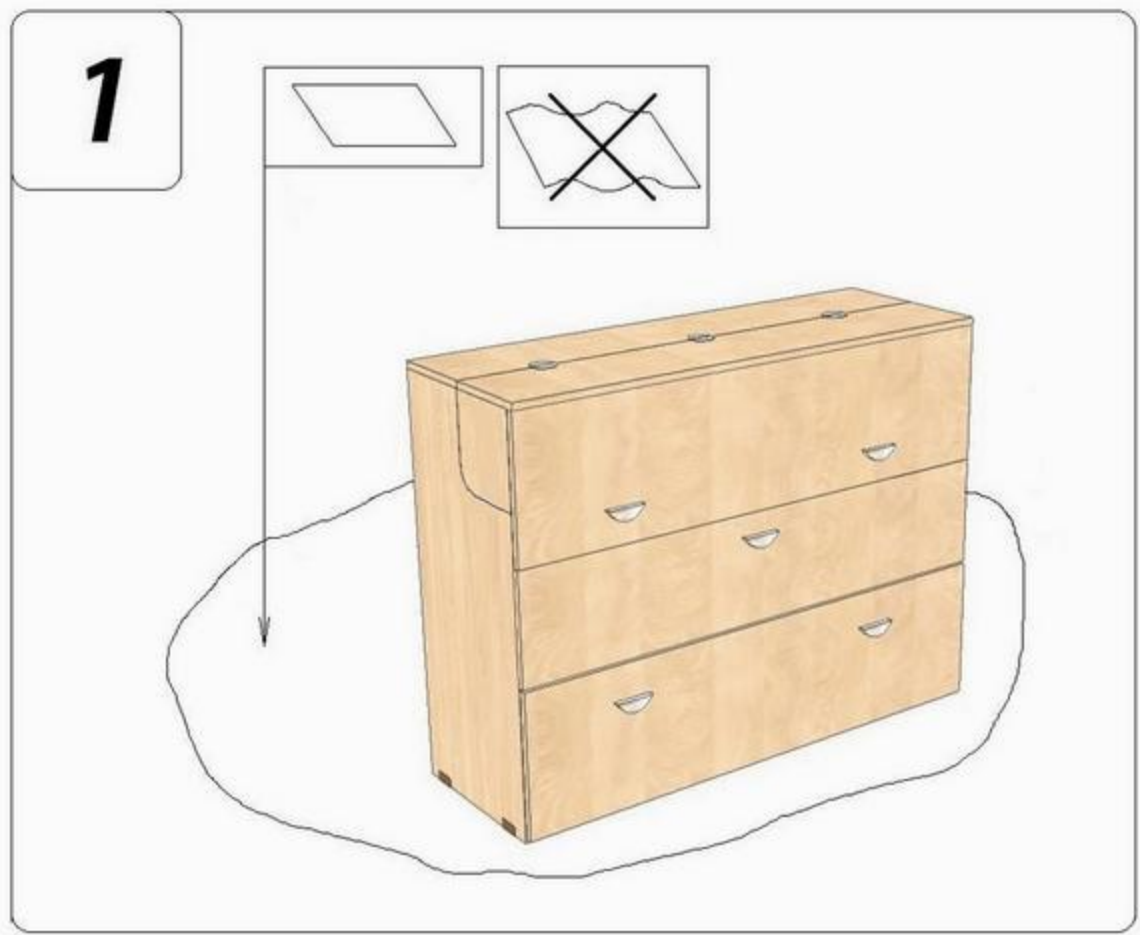
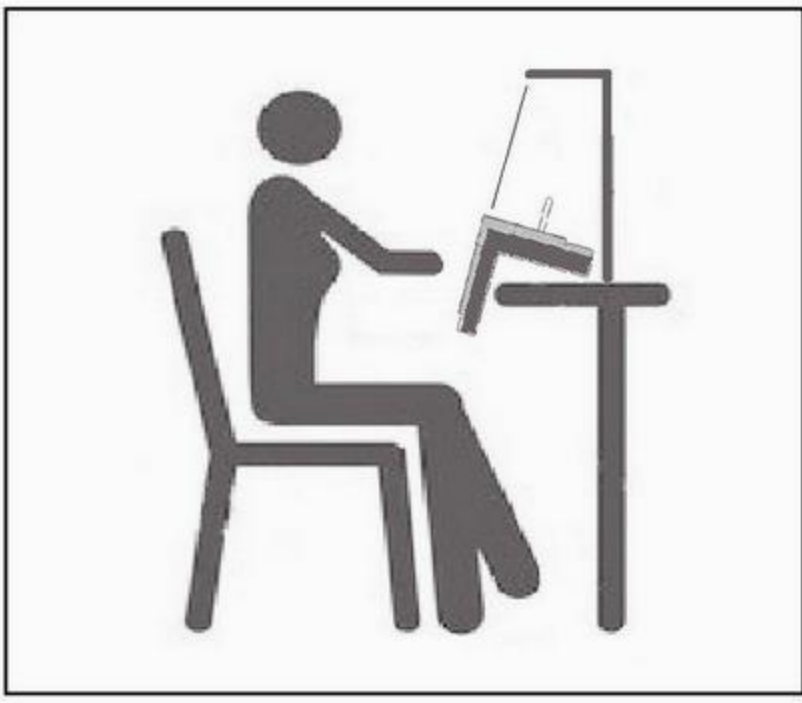

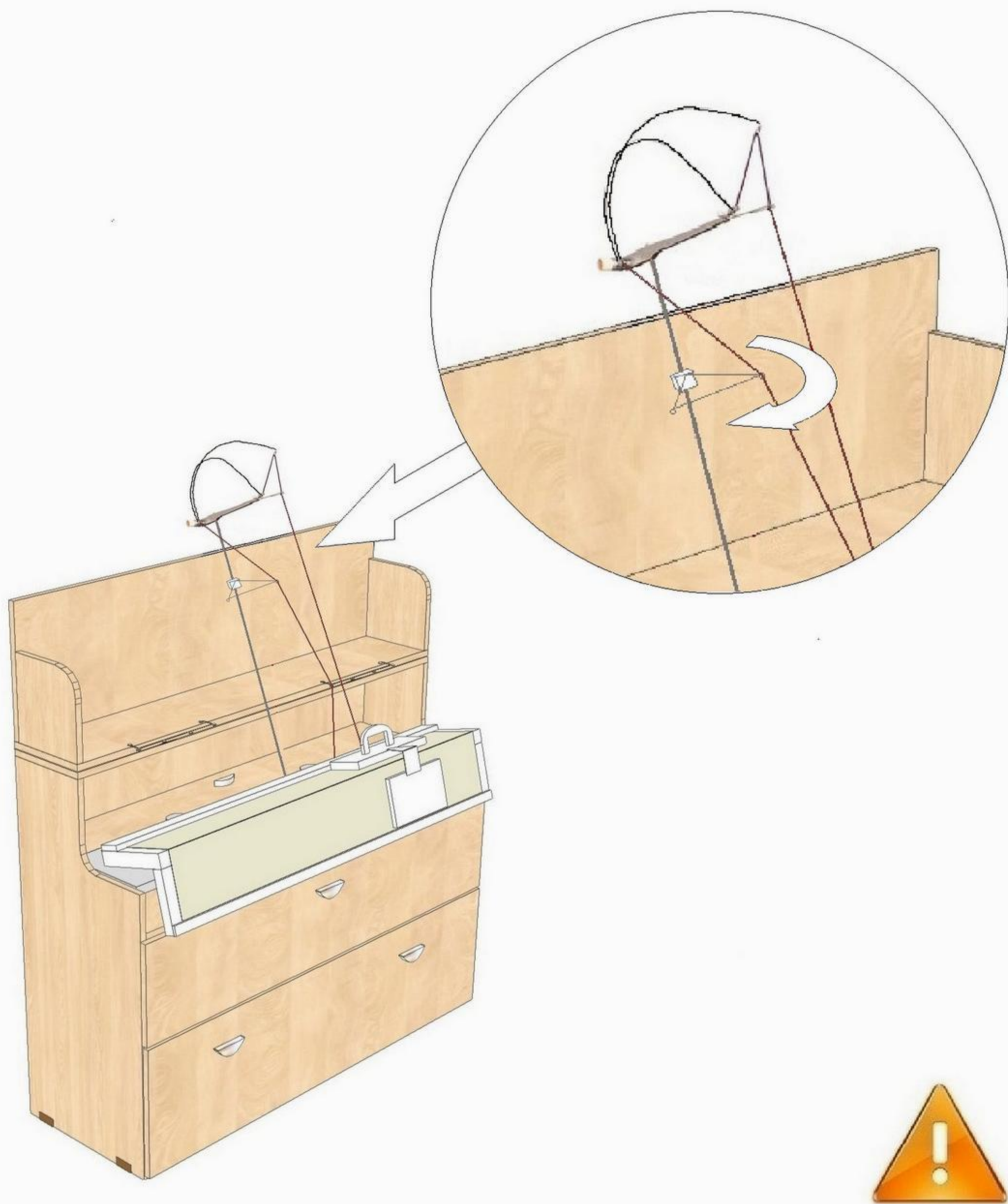

**Для обеспечения правильного схода нити с конуса рекомендуем использовать любой из восьми наиболее подходящий нитенаправитель стола и нитенаправитель на стойке вязальной машины , предварительно повернув его в свою сторону.**